

SH W1014H Gas Spring Monitor Wall Mounts

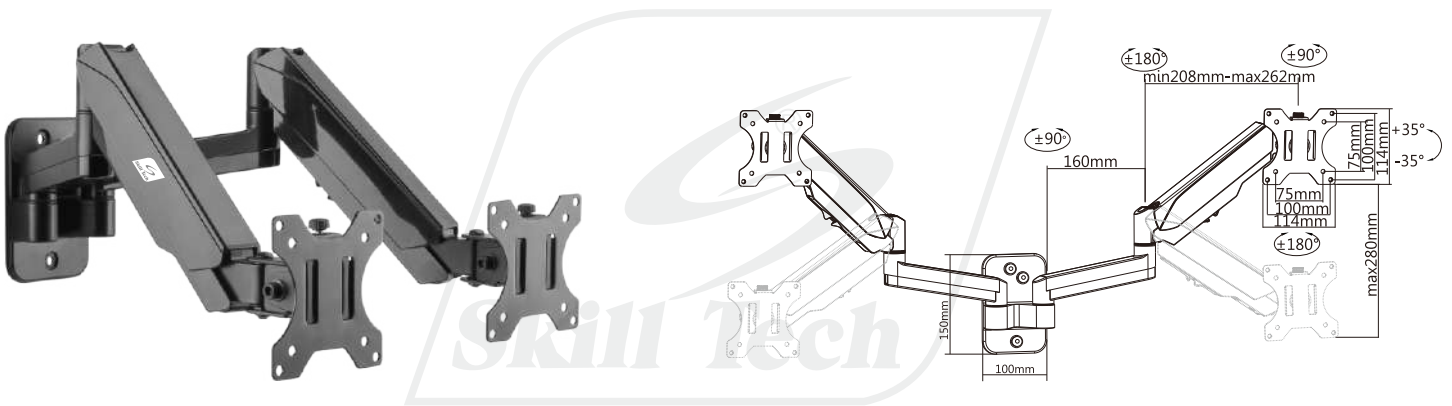

• Focal Distance

• Monitor Angle

• Monitor Height



Weight Capacity
1-8kg/2.2-17.6lbs(x2)

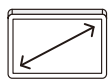

Screen Size
17"-32"



Tilt Range
 $+35^\circ$ -- -35°

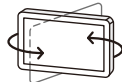

Swivel Range
 $+90^\circ$ -- -90°

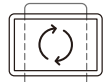

Screen Rotation
 $+180^\circ$ -- -180°

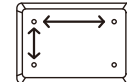

VESA Compatible
75x75 100x100



Curved TV

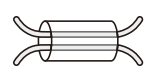

Cable Management

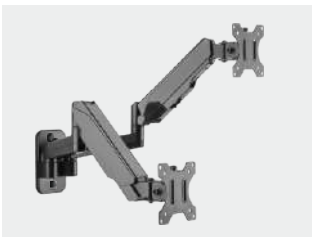

Adjustable gas pressure accommodates smooth adjustment for different weight of monitors.



Three mounting holes are easy for installation, and securely holds your monitor.

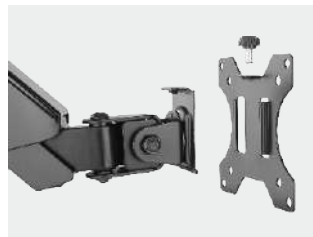

Quick-release VESA plate for easy installation

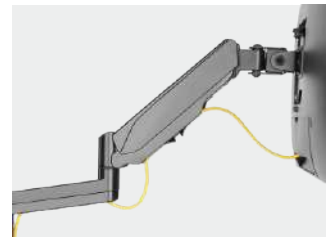

Cable management creates a clutter-free desktop.